

Ga aan de slag met je gewipte tegels!

Deze manual legt in stappen uit hoe je zelf van je gewipte stoeptegel en betonklinker een krukje, bank, kast of bloembak maakt.

MANUAL



BANK

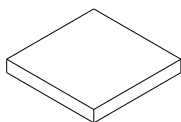

3x

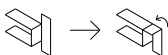

8x

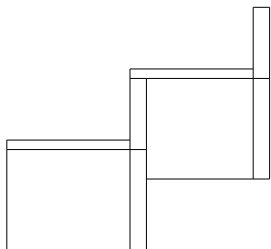

1

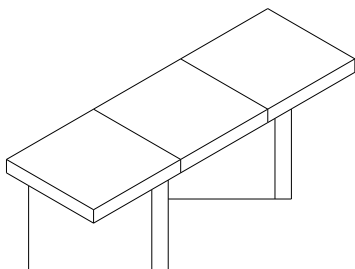

2

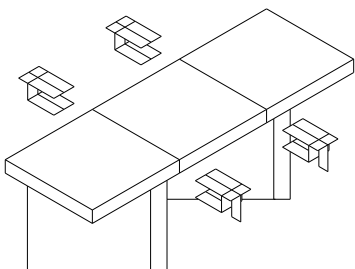

3

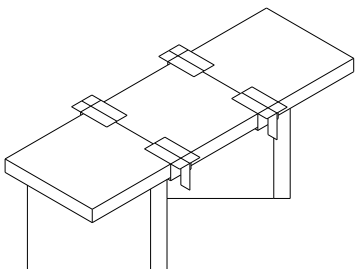

KAST

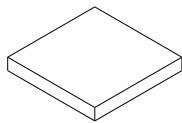

9x

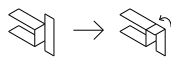

8x

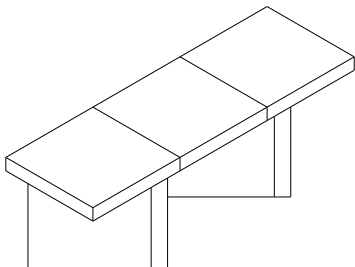

1

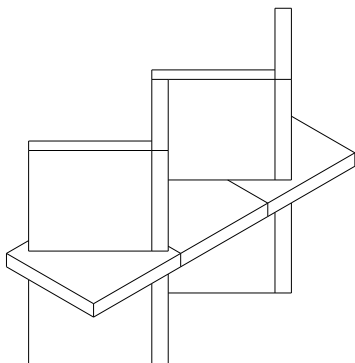

2

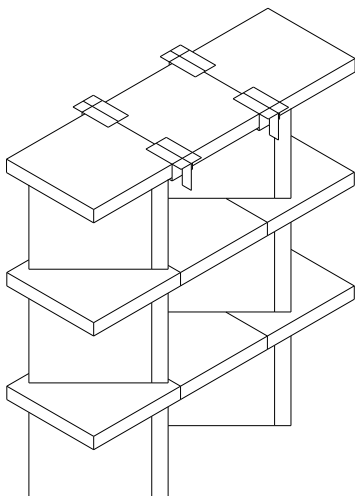

KRUK / BANK

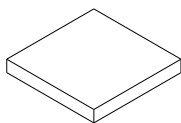

3x - 12x



12x - 30x

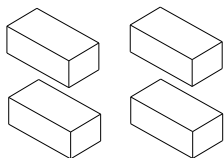

1

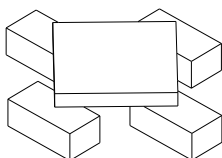

2

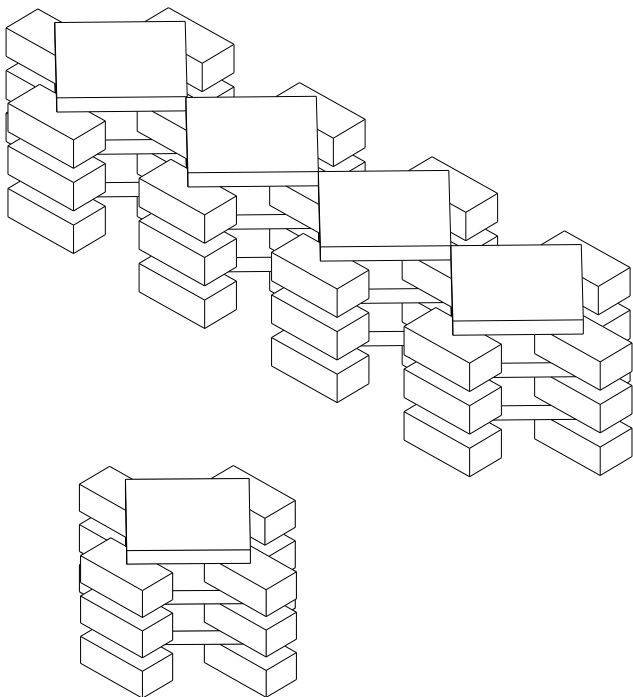

KOLOM

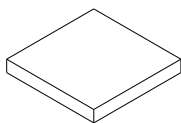

15x



60x

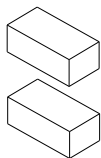
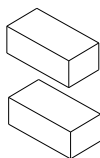

1

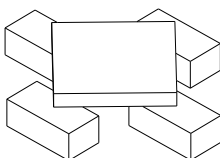

2

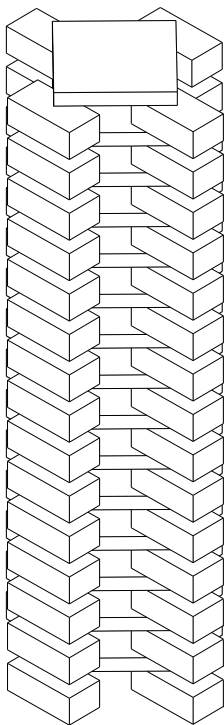

BLOEM



30 - 50x

BAK

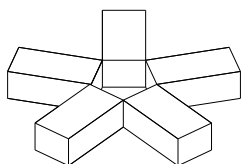

1

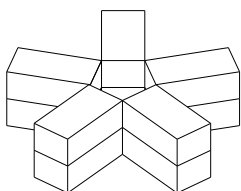

2

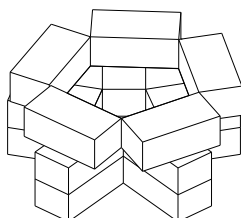

3

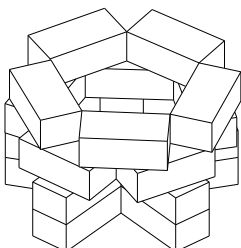

4

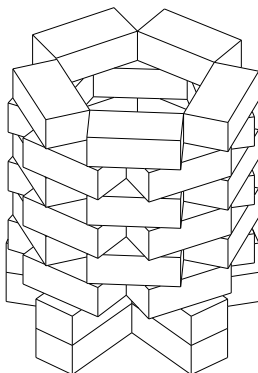
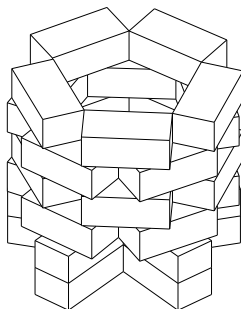

BLOEM BAK



175x

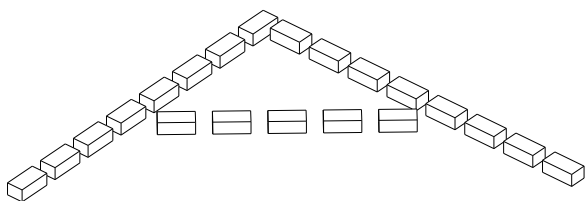

1

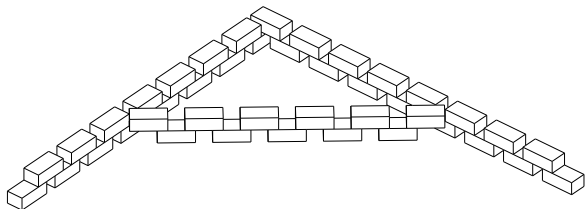

2

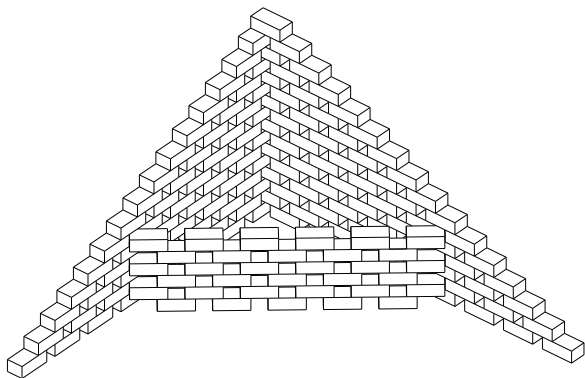

Deze serie toepassingen is ontworpen door Verloren Bekisting en is tot stand gekomen vanuit een samenwerking tussen onderstaande organisaties en instanties.

